

Installation Guide

Gigabit Desktop DSL Gateway

Images may differ from the actual product.

© 2026 TP-Link 7100002433 REV1.0.0

More Resources

Main Site	https://www.omadanetworks.com/
Video Center	https://support.omadanetworks.com/video/
Documents	https://support.omadanetworks.com/document/
Product Support	https://support.omadanetworks.com/product/
Technical Support	https://support.omadanetworks.com/contact-support/

Warranty

For details on the warranty period, policy, and procedures, visit <https://support.omadanetworks.com/warranty-services/>.

Support

For technical support, user guides, and other information, please visit <https://support.omadanetworks.com/>, or simply scan the QR code.



1 Hardware Overview

Front Panel

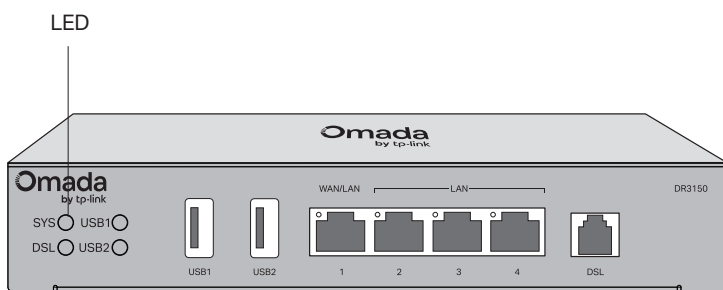

Interface	Description
USB1/USB2	USB 2.0 port for USB modem and USB storage device.
WAN/LAN	By default, it is a WAN port. You can configure it to a LAN port on the management page.
LAN (Ports 2-4)	Gigabit RJ45 LAN port.
DSL	For connecting the gateway to the internet. Connect it directly to the phone jack.
Kensington Security Slot	Secure the lock (not provided) into the security slot to prevent the device from being stolen.
Grounding Terminal	The gateway already comes with lightning protection mechanism. For detailed lightning protection measures, refer to the Lightning Protection Guide: https://support.omadanetworks.com/r/1004/
Power Socket	Connect to the power outlet via the provided power adapter.

Back Panel

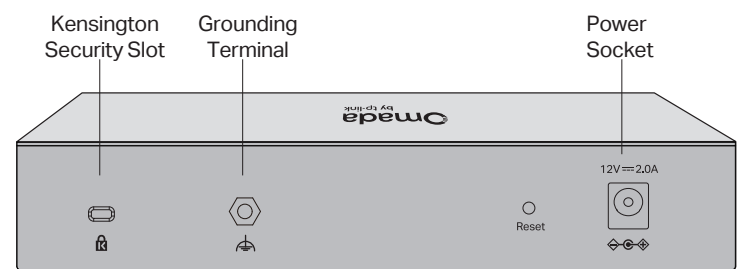

LED	Indication
SYS	Slow Flashing: System is running normally. Quick Flashing: The gateway is being reset. On/Off: System is starting up or running abnormally.
DSL	On: DSL synchronization is complete, and the device can access internet. Flashing: DSL synchronization is in progress. Off: DSL synchronization failed or the DSL port is not connected.
USB1/USB2	For USB Modem: Flashing: A modem is connected, and it is initializing. On: The modem is loaded. Off: No modem is inserted, or it is corrupted or incompatible. For USB Storage: On: A USB storage device is inserted and identified. Off: No USB storage device is inserted, or it is corrupted or incompatible.
Link/Act	On: Connecting to a device but no activity Off: No device connected to the corresponding port Flashing: Transmitting or receiving data

- **Reset:** Press and hold the button for 5 seconds, the SYS LED will flash quickly, indicating the device is being reset to its factory default settings.

2 Hardware Connection

Connect to the internet using one or multiple options.

Option 1: Connect to Internet via Phone Cable

If you don't need the phone service, just directly connect the gateway to the phone jack with the provided phone cable.

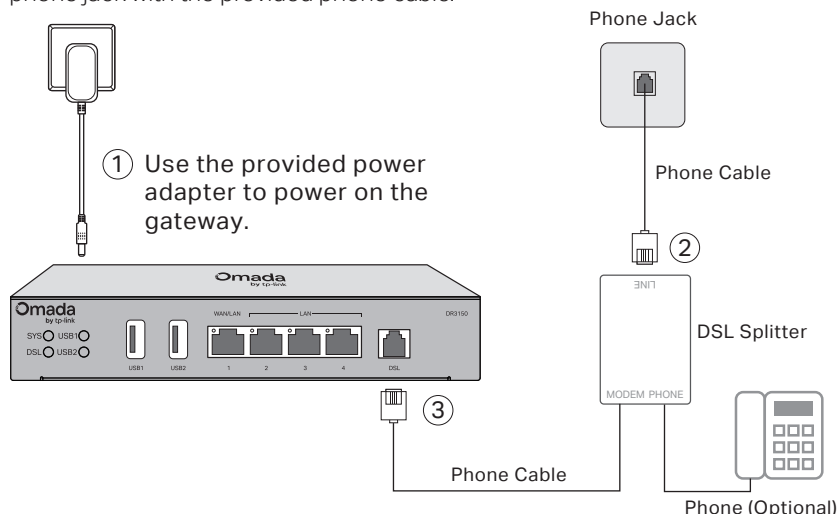

Option 2: Connect to Internet via Ethernet Cable

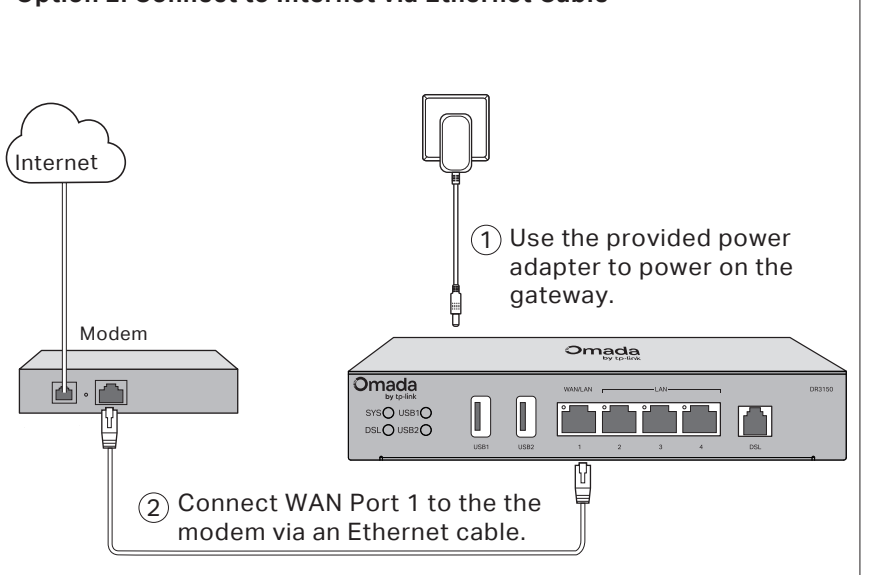

3 Software Configuration

The gateway supports two configuration options:

- Standalone Mode: Configure and manage the gateway by itself.
- Controller Mode: Configure and manage network devices centrally. This is recommended for large-scale networks, which consist of a large number of Omada devices such as access points, switches and gateways.

Note:
1. When the gateway is managed by a controller, configurations of the gateway will be overridden by the controller.
2. For detailed configurations, refer to the User Guide of the gateway and the controller. The guides can be found at <https://support.omadanetworks.com/document/>.

Option 1: Standalone Mode

1. Connect a computer to a LAN port of the gateway with an RJ45 cable properly.
Note: If your computer is configured with a fixed IP, change it to **Obtain an IP address automatically**.
2. Launch a web browser, enter <https://omadaer.net>, and then follow the web instructions to complete the quick setup.
Note: Ensure that the ports you select as WAN ports align with the actual setup.

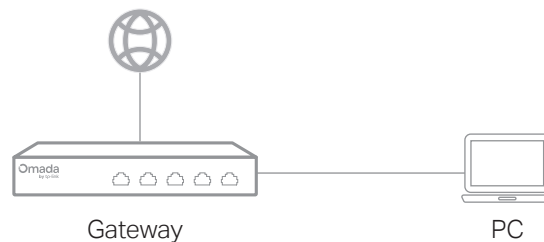

Option 2: Controller Mode

Note: The Omada Controller must have network access to your Omada devices in order to find, adopt, and manage them.

To set up an Omada gateway with an Omada Controller, scan the QR code or refer to the Omada Controller configuration guide at <https://www.omadanetworks.com/support/faq/4096/>.



Scan for Controller Configuration Guide

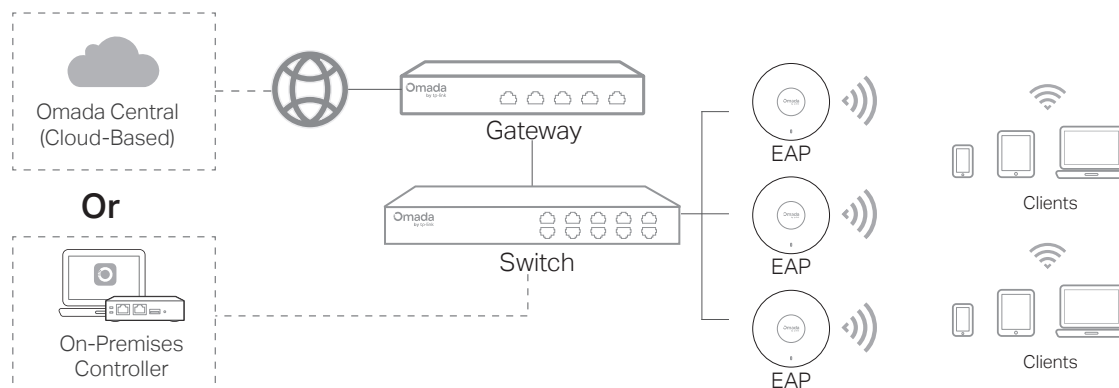

Omada App

With the TP-Link Omada app, you can access and manage your Omada devices at a local site or remotely with a tap of your phone. You can download and install the TP-Link Omada app from the App Store or Google Play.



Scan for Omada App



Download Omada App

4 Installation

Option 1: Desktop Installation

1. Remove the adhesive covers from the rubber feet.
2. Turnover the device and attach the supplied rubber feet to the bottom of the device to prevent it from slipping when placed on a desktop.
3. Place the device on a flat table.

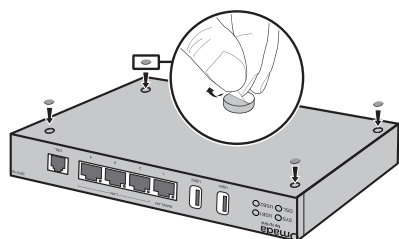

Option 2: Wall Mounting

1. Drill two holes on the wall according to the mounting holes on the bottom.
2. Secure the gateway to the wall with two suitable screws (not provided).

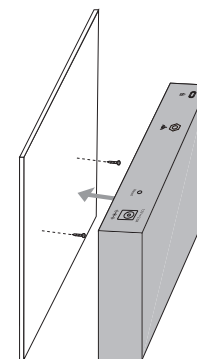

Safety Information

- Keep the device away from water, fire, humidity or hot environments.
- Do not attempt to disassemble, repair, or modify the device. If you need service, please contact us.
- Do not use damaged charger or USB cable to charge the device.
- Do not use any other chargers than those recommended.
- Adapter shall be installed near the equipment and shall be easily accessible.
- Place the device with its bottom surface downward.
- Use only power supplies listed in the user instructions. Refer to the User Manual on the product support page.

EU Declaration of Conformity

TP-Link hereby declares that the gateway is in compliance with the essential requirements and other relevant provisions of directives 2014/30/EU, 2014/35/EU, 2009/125/EC, 2011/65/EU and (EU)2015/863. The original EU declaration of conformity may be found at <https://www.tp-link.com/en/support/ce/>.

UK Declaration of Conformity

TP-Link hereby declares that the gateway is in compliance with the essential requirements and other relevant provisions of the Electromagnetic Compatibility Regulations 2016 and Electrical Equipment (Safety) Regulations 2016.

The original UK declaration of conformity may be found at <https://www.tp-link.com/support/ukca/>